

# Analog Devices Welcomes Hittite Microwave Corporation

NO CONTENT ON THE ATTACHED DOCUMENT HAS CHANGED



**THIS PAGE INTENTIONALLY LEFT BLANK**

**GAAS MMIC SMT PASSIVE FREQUENCY DOUBLER, 0.7 - 2.4 GHz INPUT**
**Typical Applications**

The HMC156C8 is suitable for:

- Wireless Local Loop
- LMDS, VSAT, and Point-to-Point Radios
- UNII & HiperLAN
- Test Equipment

**Features**

- Conversion Loss: 15 dB
- Fo, 3Fo, 4Fo Isolation: 38 dB
- Input Drive Level: 10 to 20 dBm

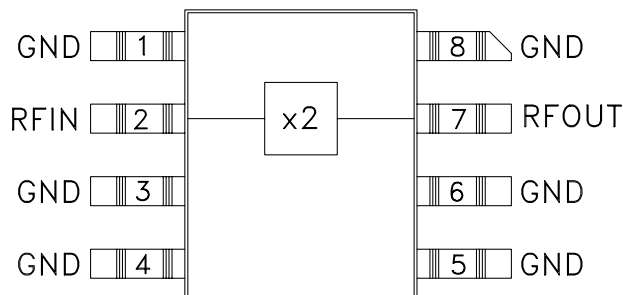
**Functional Diagram**

**General Description**

The HMC156C8 is a miniature frequency doubler in a non-hermetic ceramic surface mount package. Suppression of undesired fundamental and higher order harmonics is 38 dB typical with respect to input signal levels. The doubler uses the same diode/balun technology used in Hittite MMIC mixers, features small size and requires no DC bias.

**Electrical Specifications,  $T_A = +25^\circ\text{C}$ , As a Function of Drive Level**

Parameter	Input = +10 dBm			Input = +15 dBm			Input = +20 dBm			Units
	Min.	Typ.	Max.	Min.	Typ.	Max.	Min.	Typ.	Max.	
Frequency Range, Input	1.1 - 2.1			0.8 - 2.4			0.7 - 2.3			GHz
Frequency Range, Output	2.2 - 4.2			1.6 - 4.8			1.4 - 4.6			GHz
Conversion Loss		17	22		15	20		15	20	dB
FO Isolation (with respect to input level)	42	47		43	47		27	35		dB
3FO Isolation (with respect to input level)	45	55		44	55		29	40		dB
4FO Isolation (with respect to input level)	28	38		31	38		25	35		dB



**GAAS MMIC SMT PASSIVE FREQUENCY DOUBLER, 0.7 - 2.4 GHz INPUT**

**Conversion Gain vs. Drive Level**

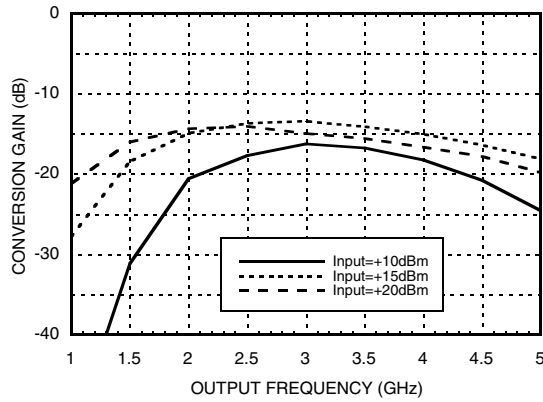

**Isolation @ +15 dBm Drive Level\***

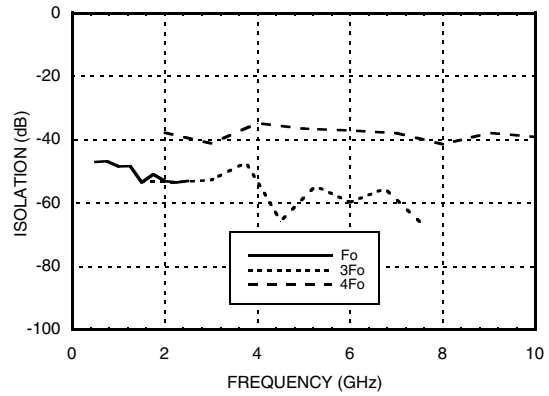

\*With respect to input level

**Input Return Loss vs. Drive Level**

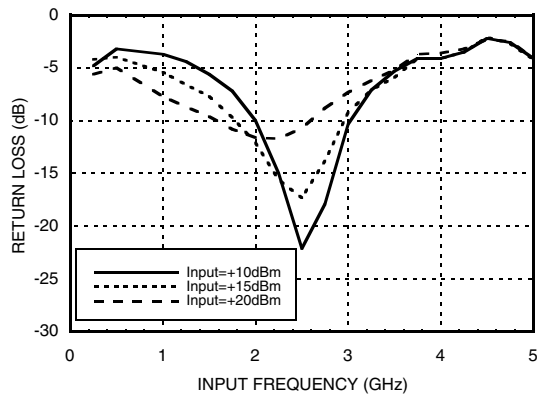

**Output Return Loss @ +15 Drive Level**

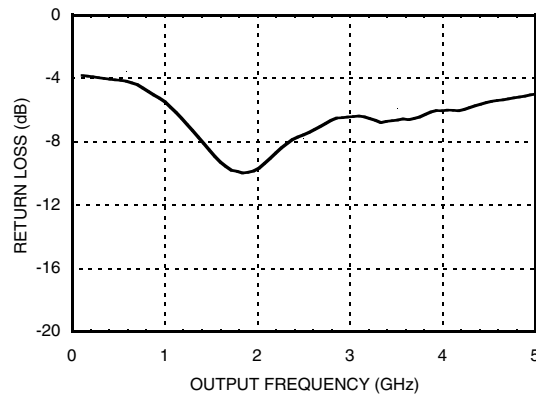



**GAAS MMIC SMT PASSIVE FREQUENCY DOUBLER, 0.7 - 2.4 GHz INPUT**

**Absolute Maximum Ratings**

Input Drive	+27 dBm
Storage Temperature	-65 to +150 °C
Operating Temperature	-40 to +85 °C



**ELECTROSTATIC SENSITIVE DEVICE  
OBSERVE HANDLING PRECAUTIONS**

FREQUENCY MULTIPLIERS - PASSIVE - SMT

**Outline Drawing**

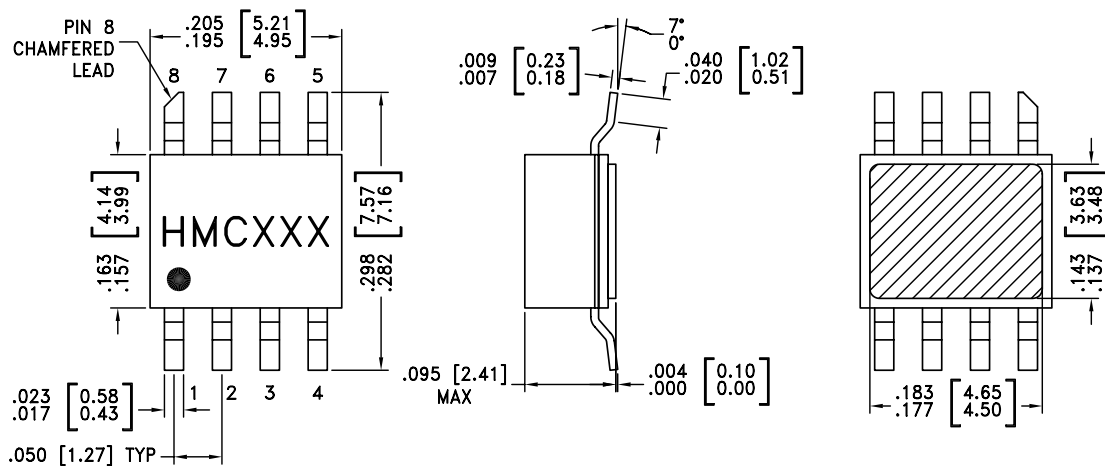

**NOTES:**

1. PACKAGE BODY MATERIAL: WHITE ALUMINA 92%
2. LEAD, PACKAGE BOTTOM MATERIAL: COPPER
3. PLATING: ELECTROLYTIC GOLD 100 - 200 MICROINCHES OVER ELECTROLYTIC NICKEL 100 TO 200 MICROINCHES.
4. DIMENSIONS ARE IN INCHES [MILLIMETERS].
5. PACKAGE LENGTH AND WIDTH DIMENSIONS DO NOT INCLUDE LID SEAL PROTRUSION .005 PER SIDE.
6. ALL GROUND LEADS AND GROUND PADDLE MUST BE SOLDERED TO PCB PF GROUND.

**GAAS MMIC SMT PASSIVE FREQUENCY DOUBLER, 0.7 - 2.4 GHz INPUT**

**Evaluation PCB**

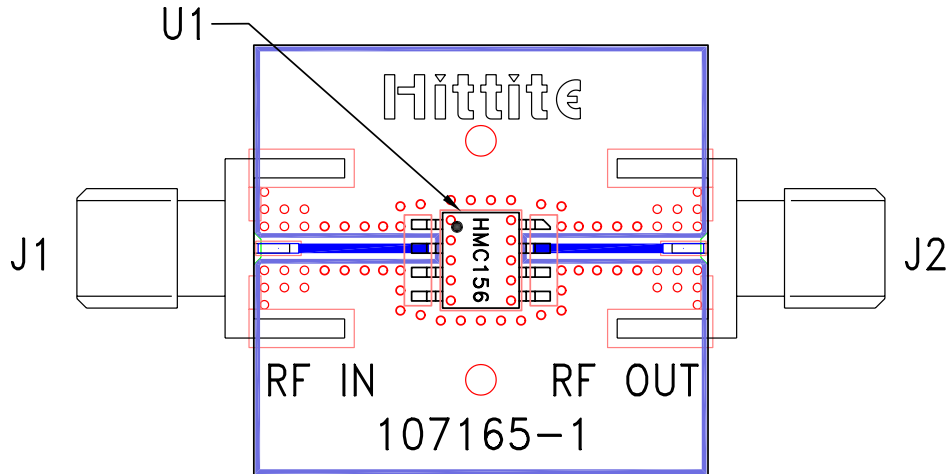

**List of Materials for Evaluation PCB 107196 [1]**

Item	Description
J1, J2	PCB Mount SMA Connector
U1	HMC156C8, Doubler
PCB [2]	107165 Eval Board

[1] Reference this number when ordering complete evaluation PCB

[2] Circuit Board Material: Rogers 4350

The circuit board used in the final application should be generated with proper RF circuit design techniques. Signal lines should have 50 ohm impedance while the package ground leads and exposed paddle should be connected directly to the ground plane similar to that shown. The evaluation circuit board shown is available from Hittite upon request.